

Integrated Stereo Amplifier **A-905TX**

Instruction Manual

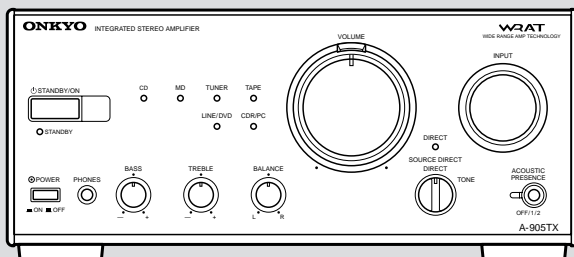

Before using

Connections

Preparations

Operation

Other Information

Thank you for purchasing the ONKYO A-905TX Integrated Stereo Amplifier.

Please read this manual thoroughly before making any connection or turning on the power. Follow these instructions to obtain optimum performance and maximum listening enjoyment from your new A-905TX. Please retain this manual for future reference.

Main Features

- **High-Quality Separate Component**
- **WRAT (Wide Range Amp Technology) Circuit**
- **Processor In/Out, Subwoofer Pre Out**
- **Six-audio Source Inputs**
- **Acoustic Presence Circuit Naturally Enhances the Extreme Low Range**
- **Source Direct Function**
- **System Control Remote Controller**

Memory Preservation

This unit does not require memory preservation batteries. A built-in memory power back-up system preserves the contents of the memory during power failures and even when the unit is unplugged. The unit must be plugged in order to charge the back-up system.

The memory preservation period after the unit has been unplugged varies depending on climate and placement of the unit. On the average, memory contents are protected over a period of a few weeks after the last time the unit has been unplugged. This period is shorter when the unit is exposed to a highly humid climate.

WARNING:

TO REDUCE THE RISK OF FIRE OR ELECTRIC SHOCK, DO NOT EXPOSE THIS APPLIANCE TO RAIN OR MOISTURE.

CAUTION:

TO REDUCE THE RISK OF ELECTRIC SHOCK, DO NOT REMOVE COVER (OR BACK). NO USER-SERVICEABLE PARTS INSIDE. REFER SERVICING TO QUALIFIED SERVICE PERSONNEL.



The lightning flash with arrowhead symbol, within an equilateral triangle, is intended to alert the user to the presence of uninsulated "dangerous voltage" within the product's enclosure that may be of sufficient magnitude to constitute a risk of electric shock to persons.



The exclamation point within an equilateral triangle is intended to alert the user to the presence of important operating and maintenance (servicing) instructions in the literature accompanying the appliance.

Important Safeguards

- 1. Read Instructions** – All the safety and operating instructions should be read before the appliance is operated.
- 2. Retain Instructions** – The safety and operating instructions should be retained for future reference.
- 3. Heed Warnings** – All warnings on the appliance and in the operating instructions should be adhered to.
- 4. Follow Instructions** – All operating and use instructions should be followed.
- 5. Water and Moisture** – The appliance should not be used near water – for example, near a bathtub, washbowl, kitchen sink, laundry tub, in a wet basement, or near a swimming pool, and the like.
- 6. Carts and Stands** – The appliance should be used only with a cart or stand that is recommended by the manufacturer.
 - 6A.** An appliance and cart combination should be moved with care. Quick stops, excessive force, and uneven surfaces may cause the appliance and cart combination to overturn.
- 7. Wall or Ceiling Mounting** – The appliance should be mounted to a wall or ceiling only as recommended by the manufacturer.
- 8. Ventilation** – The appliance should be situated so that its location or position does not interfere with its proper ventilation. For example, the appliance should not be situated on a bed, sofa, rug, or similar surface that may block the ventilation openings; or if placed in a built-in installation, such as a bookcase or cabinet that may impede the flow of air through the ventilation openings, there should be free space of at least 20 cm (8 in.) and an opening behind the appliance.
- 9. Heat** – The appliance should be situated away from heat sources such as radiators, heat registers, stoves, or other appliances (including amplifiers) that produce heat.
- 10. Power Sources** – The appliance should be connected to a power supply only of the type described in the operating instructions or as marked on the appliance.
- 11. Polarization** – If the appliance is provided with a polarized plug having one blade wider than the other, please read the following information: The polarization of the plug is a safety feature. The polarized plug will only fit the outlet one way. If the plug does not fit fully into the outlet, try reversing it. If there is still trouble, the user should seek the services of a qualified electrician. Under no circumstances should the user attempt to defeat the polarization of the plug.
- 12. Power-Cord Protection** – Power-supply cords should be routed so that they are not likely to be walked on or pinched by items placed upon or against them, especially near plugs, convenience receptacles, and the point where they exit from the appliance.
- 13. Cleaning** – The appliance should be cleaned only as recommended by the manufacturer.
- 14. Nonuse Periods** – The power cord of the appliance should be unplugged from the outlet when left unused for a long period of time.
- 15. Object and Liquid Entry** – Care should be taken so that objects do not fall and liquids are not spilled into the enclosure through openings.
- 16. Damage Requiring Service** – The appliance should be serviced by qualified service personnel when:
 - A. The power-supply cord or the plug has been damaged; or
 - B. Objects have fallen, or liquid has been spilled into the appliance; or
 - C. The appliance has been exposed to rain; or
 - D. The appliance does not appear to operate normally or exhibits a marked change in performance; or
 - E. The appliance has been dropped, or the enclosure damaged.
- 17. Servicing** – The user should not attempt to service the appliance beyond that described in the operating instructions. All other servicing should be referred to qualified service personnel.

PORTABLE CART WARNING



Precautions

1. Warranty Claim

You can find the serial number on the rear panel of this unit. In case of warranty claim, please report this number.

2. Recording Copyright

Recording of copyrighted material for other than personal use is illegal without permission of the copyright holder.

3. AC Fuse

The fuse is located inside the chassis and is not user-serviceable. If power does not come on, contact your Onkyo authorized service station.

4. Care

From time to time you should wipe the front and rear panels and the cabinet with a soft cloth. For heavier dirt, dampen a soft cloth in a weak solution of mild detergent and water, wring it out dry, and wipe off the dirt. Following this, dry immediately with a clean cloth. Do not use rough material, thinners, alcohol or other chemical solvents or cloths since these could damage the finish or remove the panel lettering.

5. Power

WARNING

BEFORE PLUGGING IN THE UNIT FOR THE FIRST TIME, READ THE FOLLOWING SECTION CAREFULLY.

The voltage of the available power supply differs according to country or region. Be sure that the power supply voltage of the area where this unit will be used meets the required voltage (e.g., AC 230 V, 50 Hz or AC 120 V, 60 Hz) written on the rear panel.

For British model

Replacement and mounting of an AC plug on the power supply cord of this unit should be performed only by qualified service personnel.

IMPORTANT

The wires in the mains lead are coloured in accordance with the following code:

Blue : Neutral

Brown : Live

As the colours of the wires in the mains lead of this apparatus may not correspond with the coloured markings identifying the terminals in your plug, proceed as follows:

The wire which is coloured blue must be connected to the terminal which is marked with the letter N or coloured black.

The wire which is coloured brown must be connected to the terminal which is marked with the letter L or coloured red.

IMPORTANT

A 5 ampere fuse is fitted in this plug. Should the fuse need to be replaced, please ensure that the replacement fuse has a rating of 5 amperes and that it is approved by ASTA or BSI to BS1362. Check for the ASTA mark or the BSI mark on the body of the fuse.

IF THE FITTED MOULDED PLUG IS UNSUITABLE FOR THE SOCKET OUTLET IN YOUR HOME THEN THE FUSE SHOULD BE REMOVED AND THE PLUG CUT OFF AND DISPOSED OF SAFELY. THERE IS A DANGER OF SEVERE ELECTRICAL SHOCK IF THE CUT OFF PLUG IS INSERTED INTO ANY 13 AMPERE SOCKET. If in any doubt, please consult a qualified electrician.

For Canadian model

For models having a power cord with a polarized plug:

CAUTION: TO PREVENT ELECTRIC SHOCK, MATCH WIDE BLADE OF PLUG TO WIDE SLOT, FULLY INSERT.

Modele pour les Canadien

Sur les modèles dont la fiche est polarisée:

ATTENTION: POUR ÉVITER LES CHOCS ÉLECTRIQUES, INTRODUIRE LA LAME LA PLUS LARGE DE LA FICHE DANS LA BORNE CORRESPONDANTE DE LA PRISE ET POUSSER JUSQU'AU FOND.

Declaration of Conformity

We, ONKYO EUROPE
ELECTRONICS GmbH
INDUSTRIESTRASSE 20
82110 GERMERING,
GERMANY



declare in own responsibility, that the ONKYO product described in this instruction manual is in compliance with the corresponding technical standards such as EN60065, EN55013, EN55020 and EN61000-3-2, -3-3.

GERMERING, GERMANY

A. HORIUCHI

ONKYO EUROPE ELECTRONICS GmbH

Table of contents

Connections

Connecting to the ONKYO Separate Collection Series components	6
Connecting to components other than the Separate Collection Series	12
Connecting speaker systems	15

Preparations

Preparing the remote controller	17
---------------------------------------	----

Operation

Turning the unit on	18
Choosing the required source	19
Adjusting the sound	20
Source Direct function/Muting/Listening with the headphones	21
Recording	22

Other Information

Troubleshooting	23
Specifications	24
Index to parts and controls	25

Supplied accessories

Check that the following accessories are supplied with this unit.

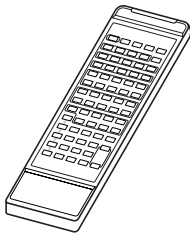

Remote controller x 1
(RC-456S)

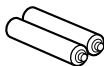

Batteries x 2
(Size AA, R6, or UM-3)

Connecting to the ONKYO Separate Collection Series components

This section introduces you to the other Separate Collection Series system components and their convenient system functions, followed by connecting instructions.

The following Separate Collection Series components are commercially available:

- T-405TX Stereo Tuner
- K-505TX Stereo Cassette Tape Deck
- C-705TX Compact Disc (CD) Player (Not available in U.S. and Canada)
- C-707CHX Compact Disc (CD) Changer (Only available in U.S. and Canada)
- MD-105TX Minidisc (MD) Recorder (Not available in U.S. and Canada)
- CDR-205TX Compact Disc (CD) Recorder (available only in part of Asia)

Note that the available components may vary according to the area.

Combination use of the unit with the above system components enables you to operate the following convenient functions:

• **Auto Power On**

- You can turn on the unit by pressing the STANDBY/ON switch on one of the system components. (The unit's POWER switch must be set to ON.)
- You can turn on all the system components at the same time by pressing the STANDBY/ON switch on the unit. (The unit's POWER switch must be set to ON.)
You can turn off each component not in use independently afterwards.

• **Direct Change**

Press the following button on the component you want to operate to switch the unit's input selector automatically to that component:

- The play button on the CD player (or changer), MD recorder, or stereo cassette tape deck, or
- The PRESET ◀/▶ buttons on the tuner.

• **Remote Control Operation**

All the system components can be operated using the supplied remote controller. The remote control buttons operate in the same way as the buttons on each component with the same indication.

• **Program Timer**

You can operate timer playback and recording using T-405TX. (Refer to the T-405TX instruction manual for more information.)

• **Sleep Timer**

You can fall asleep to a music/radio program using the timer. (Refer to the T-405TX instruction manual for more information.)

• **CD Dubbing**

Simple CD dubbing using a stereo cassette tape deck or MD recorder is possible with the pressing of a single button (CD dubbing function using an MD recorder is not available on the C-707CHX). (Refer to the K-505TX or MD-105TX Instruction Manual for more information.)

• **CD/MD Synchro Recording**

When using a stereo cassette tape deck, MD recorder or CD recorder to record from the CD player or when using a stereo cassette tape deck to record from an MD recorder, you can record with simply starting on a CD player or MD recorder. (Refer to the K-505TX, MD-105TX or CDR-205TX instruction manual for more information.)

• **Dubbing a specific track from CD**

You can specify a track on a CD and easily dub it to a connected MD recorder or CD recorder. (Refer to the MD-105TX or CDR-205TX instruction manual for more information.)

Arranging the system components

Combination example 1

Select the tuner T-405TX, CD player C-705TX (or CD changer C-707CHX), and stereo cassette tape deck K-505TX in addition to this unit. When you arrange these components, stack them as shown below.

Vertical way stacking

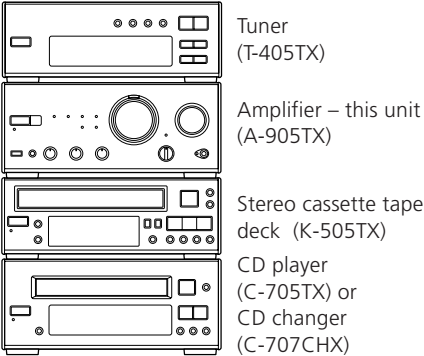

Horizontal way stacking

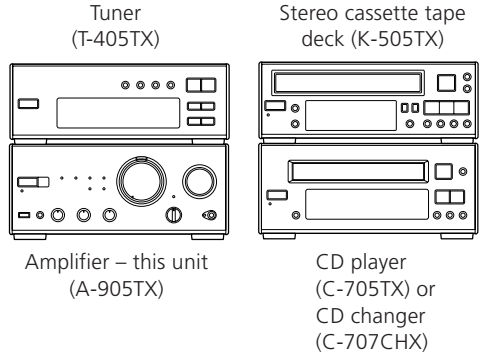

Combination example 2

Select the tuner T-405TX, CD player C-705TX and MD recorder MD-105TX in addition to this unit. When you arrange these components, stack them as shown below.

Vertical way stacking

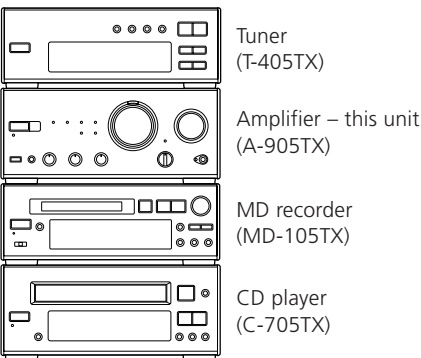

Horizontal way stacking

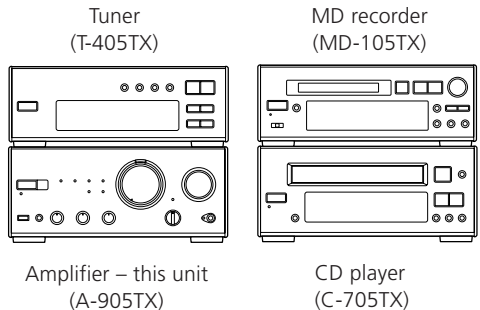

Tip

In addition to the above combination examples, you can also connect both the MD recorder MD-105TX and stereo cassette tape deck K-505TX with the tuner T-405TX, CD player C-705TX, and this unit.

Connecting to the ONKYO Separate Collection Series components

Connecting to the audio connector

Before connecting

- Do not connect the unit's AC power cord (mains lead) to a wall outlet (the mains) until you have completed all the other connections, including **RI** and AC OUTLET connections on page 11 and "Connecting speaker systems" on page 15.
- On each pair of connectors, a red connector (marked R) corresponds to the right channel, and a white connector (marked L) to the left channel. Connect white plugs of audio connection cables to L connectors and connect red plugs of audio connection cables to R connectors.
- Please refer to the instruction manual for each component when you make any connections.



- Insert the plug securely. If the connection is incomplete, noise or malfunction may result.

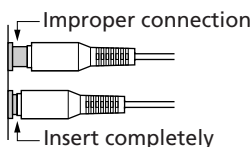

- When you use a digital audio optical cable, do not bend it sharply nor coil it tightly.
- Bundling an audio connection cable with the power cord or speaker cord may degrade the sound quality.
- Be sure to use the **RI** cable, supplied with each component (except for the A-905TX) to connect to the **RI** remote control connector. If the connection is incomplete, you will be unable to operate the device using the remote controller.
- CD players and MD recorders use heat-sensitive parts. Do not place them on top of the amplifier.

To connect both the MD recorder MD-105TX and stereo cassette tape deck K-505TX to the unit:

Connect the MD recorder to the unit following the "Connections for combination example 2" on the next page and connect the stereo cassette tape deck to the unit following the "Connections for combination example 1."

The 230-240 V model is shown in the following illustrations.

Connections for combination example 1

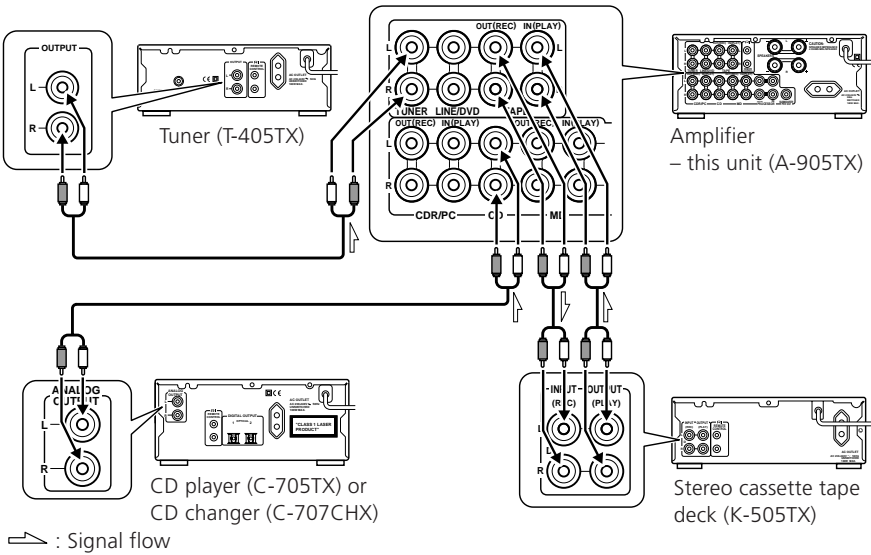

Connections for combination example 2

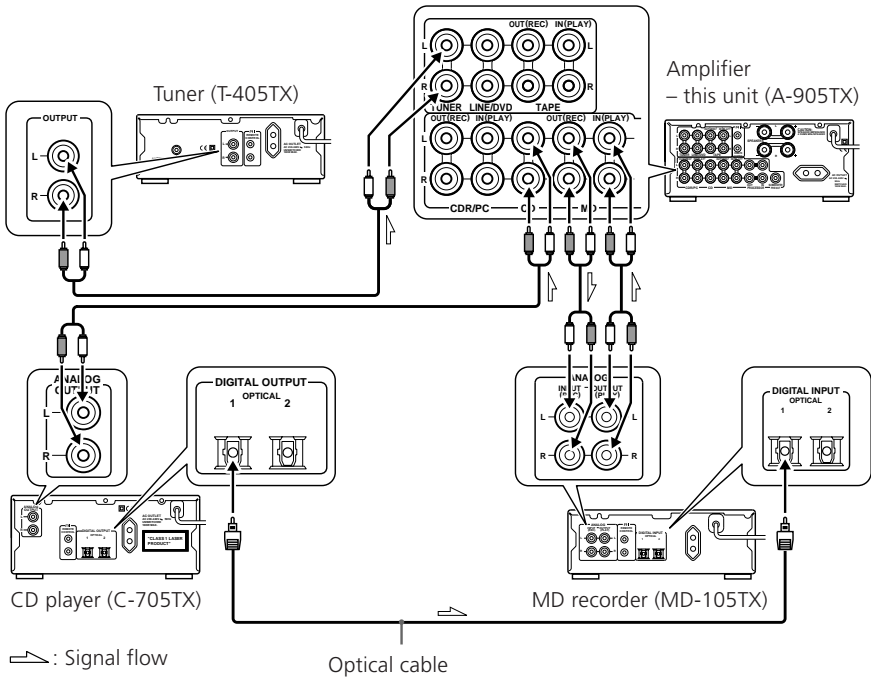

Connecting to the ONKYO Separate Collection Series components

Connecting a CD Recorder CDR-205TX:

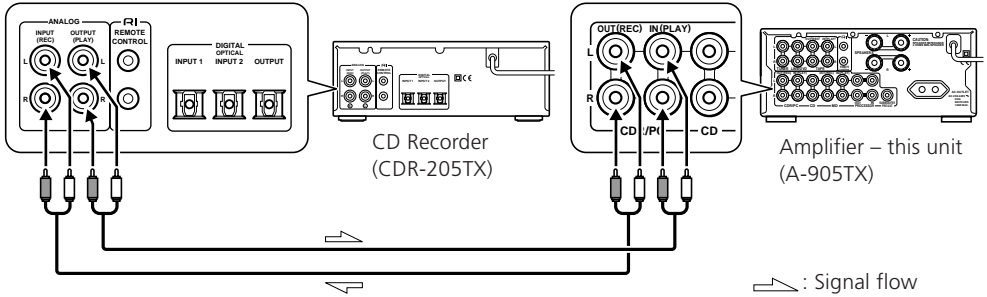

Connecting a processor such as ED-205:

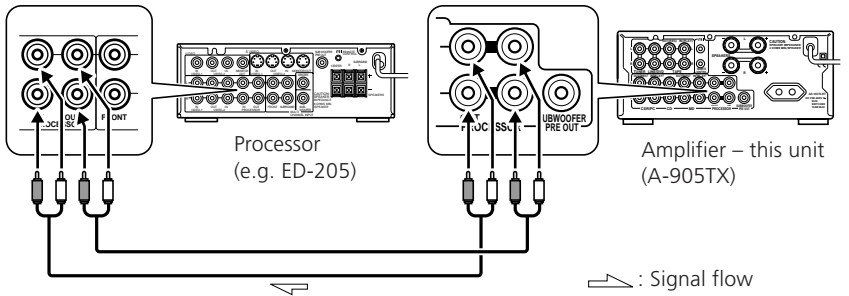

Note:

Jumper plugs have been installed on the A-905TX's PROCESSOR connectors. To connect an AV surround processor, such as ED-205, remove the jumper plugs, then connect pin cables (see page 13).

Connecting the RI connectors and AC OUTLETS

Before connecting

- The hookups on page 9, 10 is needed in addition to the **RI** (for remote control operations) and AC OUTLET (for power supply to each component) hookups on this page.
- Each component has two **RI** connectors. There is no difference between those connectors. The components may be connected in any order.
- The **RI** cable for connecting the **RI** connectors is supplied with each component (not supplied with the unit).

Connections

To use the Clock/Timer function of the tuner T-405TX's, connect the power cord as shown below and connect the **RI** cable and audio connection cables (see page 9, 10). Be sure to connect the power cord of the T-405TX to an AC outlet that supplies continuous power. Also, turn on the POWER switch on the A-905TX to use the Timer function.

Stereo cassette tape deck (K-505TX) or MD recorder (MD-105TX)
(The illustration is MD-105TX.)

CD player (C-705TX) or CD changer (C-707CHX)

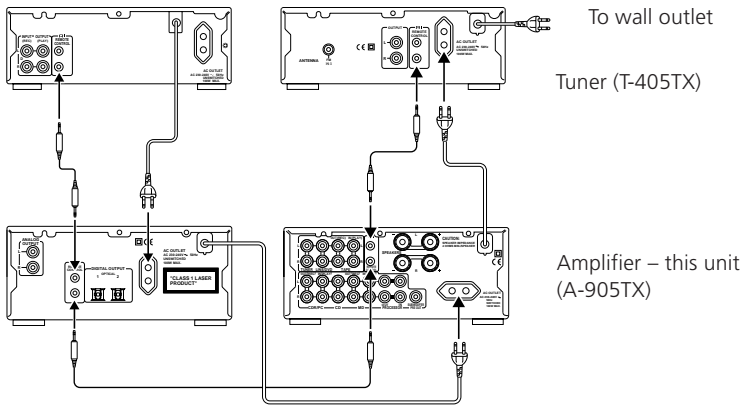

Note:

If you have a CD Recorder CDR-205TX, connect the CDR-205TX's **RI** connector to an available **RI** connector on the A-905TX.

If you connect the power cord as shown below, you can turn off the power to the entire system by simply turning off the POWER switch on the amplifier A-905TX.

Note:

If the system is connected so that you can use the tuner's T-405TX Clock/Timer function, turning off the power to the entire system will turn off the power to the tuner, and the Clock and Timer functions will no longer function. If you wish to use the clock or Timer function, leave the POWER switch set to ON.

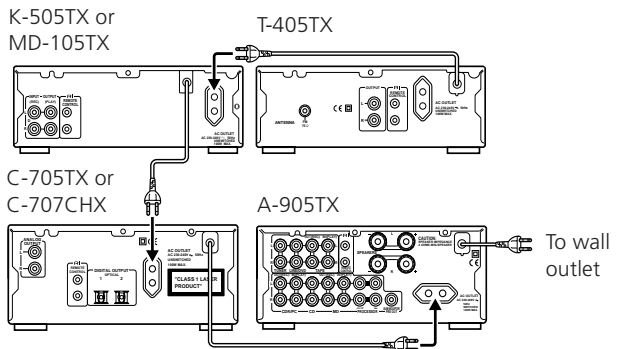

Connecting to components other than the Separate Collection Series

Connecting audio/video equipment to audio connectors

Before connecting

- Do not connect the AC power cord (mains lead) to the wall outlet (the mains) until you have completed all the other connections including the sound processor connections on the next page, the **RI** connections on page 14, and the speaker connections on page 15.
- On each pair of connectors, a red connector (marked R) corresponds to the right channel, and a white connector (marked L) to the left channel. Connect white plugs of audio connection cables to L connectors and connect red plugs of audio connection cables to R connectors.

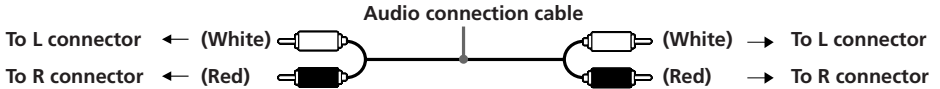

- Please refer to the instruction manual for each component when you make any connections.
- Insert the plug securely. If the connection is incomplete, noise or malfunction may result.
- If you are using an audio optical cable, do not bend or wrap it tightly.

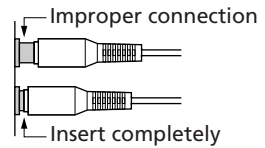

Connections

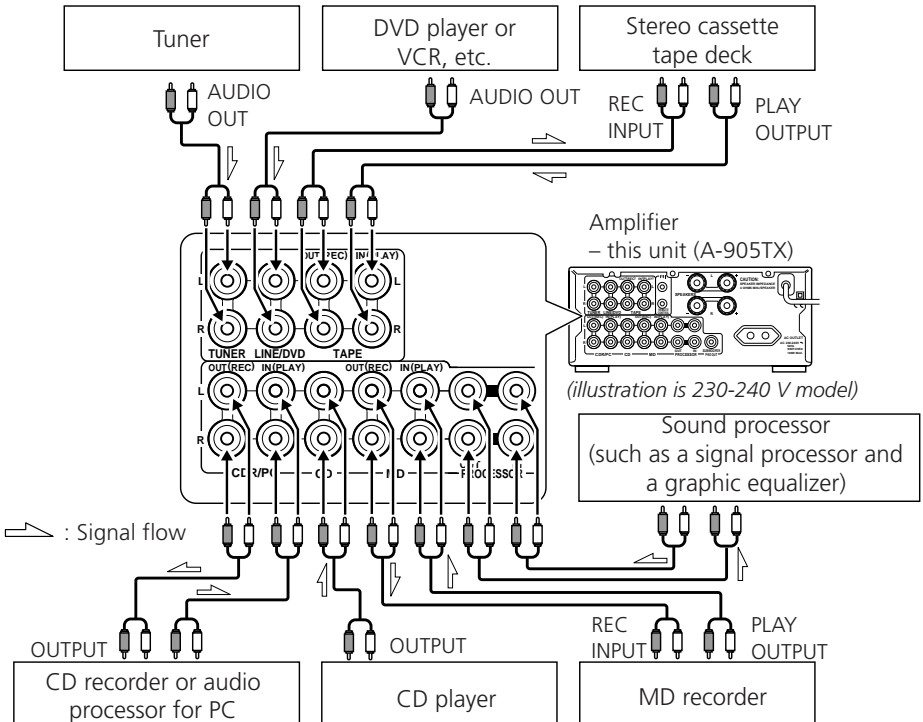

About the LINE/DVD connector

You can connect this connector to the audio output of video devices, such as a DVD player, Satellite tuner, VCR, or the audio output of a second CD player or tape deck.

Note:
You cannot connect a turntable to this connector. If you wish to connect a turntable, obtain a phono equalizer at a store and connect it as described in the instruction manual that comes with the phono equalizer.

About the CDR/PC, MD, and TAPE connectors

You can also connect a second MD recorder or tape deck to the CDR/PC connector, and/or connect a second device to the MD or TAPE connector. (If you try to connect an Onkyo tape deck, MD recorder, or CD recorder that has **RI** connectors in this way, a malfunction may occur. Do not use the **RI** cables for connections.)

You can connect a digital audio processor for a personal computer to the CDR/PC connector.

About the processor's connectors

You can connect a sound processor (e.g. graphic equalizer, surround processor, etc.) to the unit.

Before connecting

- Disconnect the jumper plugs using the PROCESSOR connectors.
 - Please retain them for future use.
 - Never connect the jumper plugs to the other connectors, as this may cause the unit to malfunction, so that the sound is not reproduced.
 - If you do not use the PROCESSOR connectors, reconnect the jumper plugs to them firmly.

Note:
When connecting jumper plugs, make sure you hold the plugs horizontally as shown in the figure and connect each plug to the IN and OUT jacks.

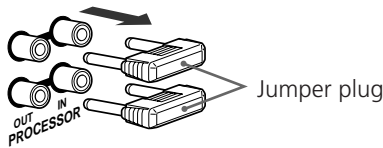

Connect the sound processor to the unit.

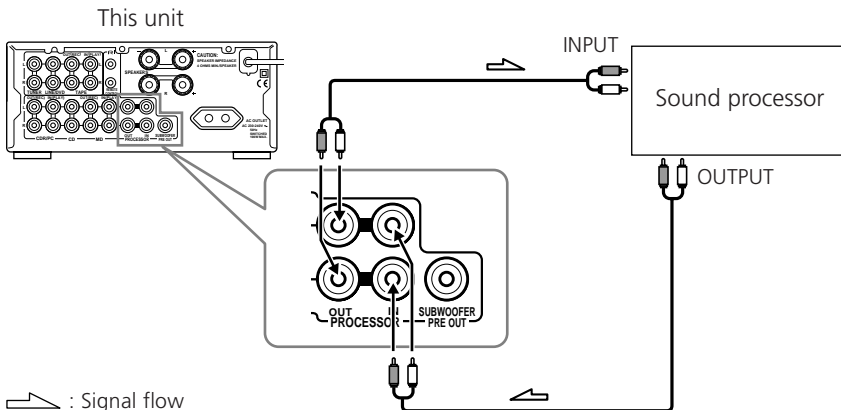

Connecting to components other than the Separate Collection Series

Connecting the **RI** cables

If your other components are made by ONKYO and those components are equipped with **RI** connectors, you can control the **RI**-connected components with the supplied remote controller.

Before connecting

- The unit must be connected in the **RI** system hookups for **RI** control operations.
- Each component has two **RI** connectors. There is no difference between these connectors.
- The components may be connected in any order.
- The hookups on the previous page are necessary independently of the **RI** system hookups.

The illustration below is an example of a **RI** hookup.

Connections

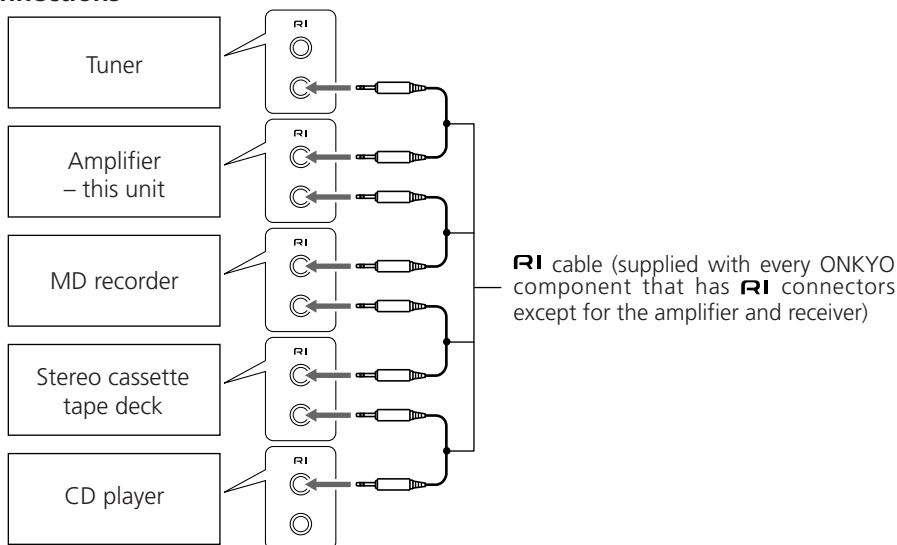

AC outlet connection

You can connect the power cord from another audio device to the rear of the A-905TX.

Since the AC outlet on the unit is a SWITCHED type outlet, you can use the POWER switch to turn on/off the power to both the A-905TX and the connected audio device.

The shape and capacity of the AC outlet may differ depending on the area of purchase. Make sure that the capacity of other components connected to this unit does not exceed the capacity that is printed on the rear panel.

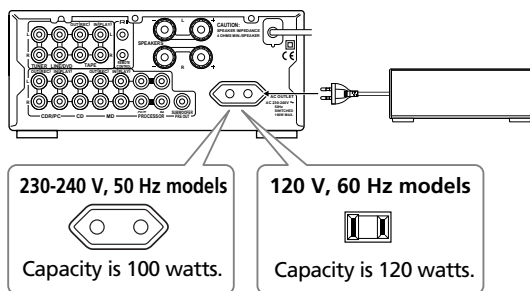

Connecting speaker systems

Connecting left and right speakers

Before connecting

- The load impedance of each speaker must be at least 4 ohms.
- Do not use unnecessarily long or extremely thin speaker cords. Otherwise, the DC resistance of the speaker cords may become too high, lowering the damping factor and causing the sound quality to deteriorate.
- Do not connect the speaker cord to the L and R connectors at the same time and do not connect two or more speakers to the same speaker connectors.

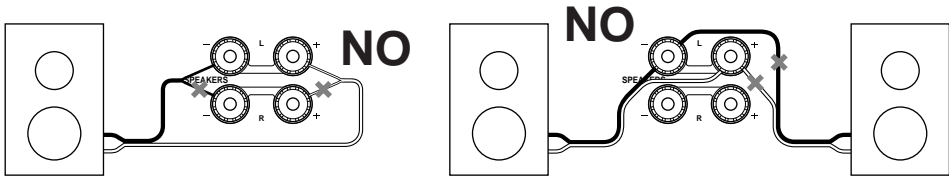

Preparing the speaker cords for connection

- 1 Strip 15 mm from the end of each cord.
- 2 Twist the stripped end of the cord.

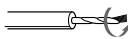
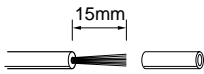

Note

To prevent damage to circuits never short-circuit the positive (+) and negative (-) speaker wires.



Connecting the speaker cords to the speaker connectors

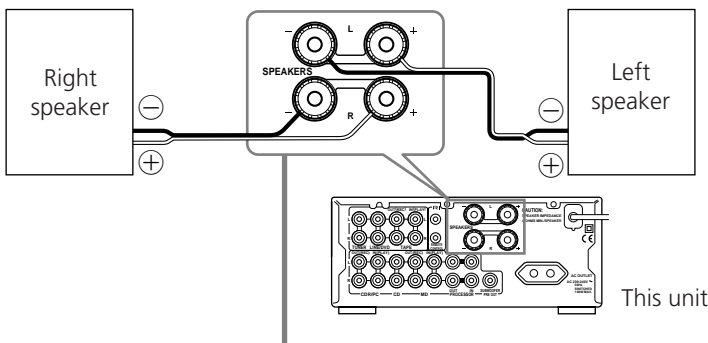

- 1 Turn the knob counter-clockwise to loosen.
- 2 Insert the stripped end of the cord.
- 3 Turn the knob clockwise to tighten.

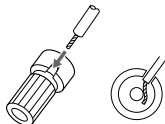

Connecting speaker systems

Connecting a subwoofer

Before connecting

- If your subwoofer isn't equipped with an amplifier, connect a separate amplifier to the unit first, then connect the subwoofer to that amplifier.
- The SUBWOOFER PRE OUT connector supplies the left and right mixed monaural signals to the subwoofer.

Connections

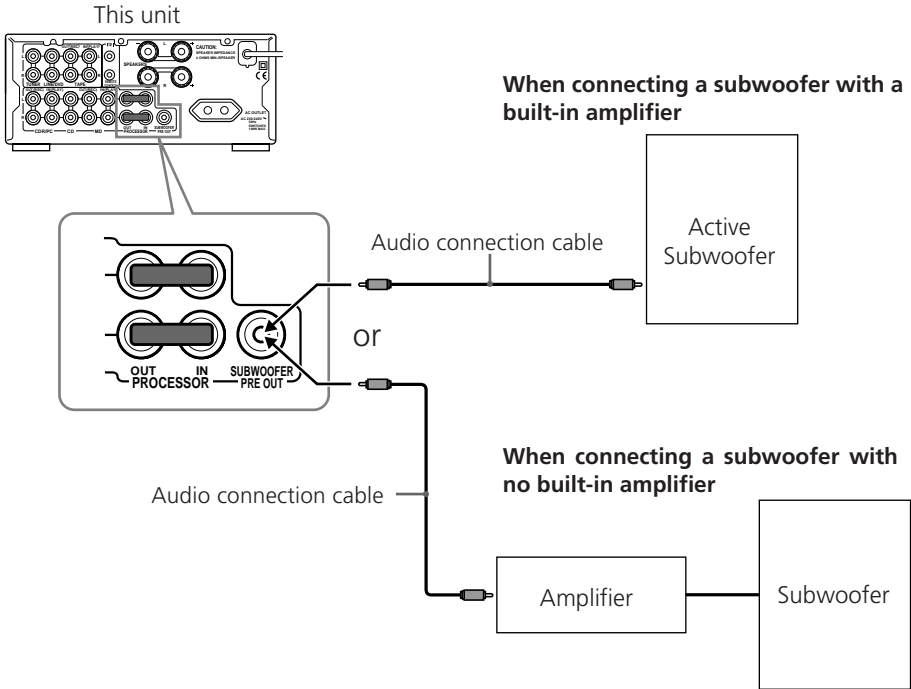

Preparing the remote controller

Installing the remote controller batteries

- 1 Remove the battery compartment cover by pressing and sliding it away from the remote controller unit.

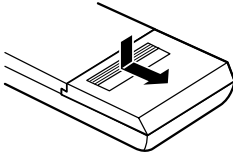

- 2 Insert two AA (R6 or UM-3)-size batteries into the battery compartment.

Carefully follow the polarity diagram (positive ⊕ and negative ⊖ symbols) inside the battery compartment.

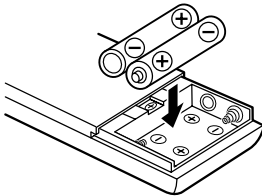

- 3 Replace the compartment cover.

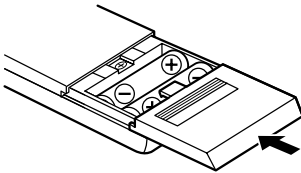

Notes

- Do not mix new batteries with old batteries or different kinds of batteries.
- To avoid corrosion, remove the batteries if the remote controller is not to be used for a long time.
- Remove dead batteries immediately to avoid damage from corrosion. If the remote controller doesn't operate smoothly, replace both the batteries at the same time.
- The life of the batteries supplied is about six months but this will vary depending on usage.

Using the remote controller

Point the remote controller toward the remote control sensor.

The STANDBY indicator lights up when the unit receives a signal from the remote controller.

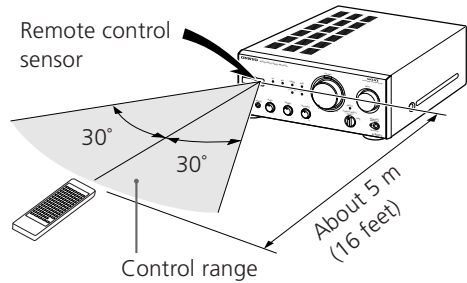

Notes

- Place the unit away from strong light such as direct sunlight or inverted fluorescent light which can prevent proper operation of the remote controller.
- Using another remote controller of the same type in the same room or using the unit near equipment which uses infrared rays may cause operational interference.
- Do not put any object such as a book on the remote controller. The buttons of the remote controller may be pressed by mistake and drain the batteries.
- Make sure the audio rack doors do not have colored glass. Placing the unit behind such doors may prevent proper remote controller operation.
- If there is any obstacle between the remote controller and the remote control sensor, the remote controller will not operate.

Operation

Turning the unit on

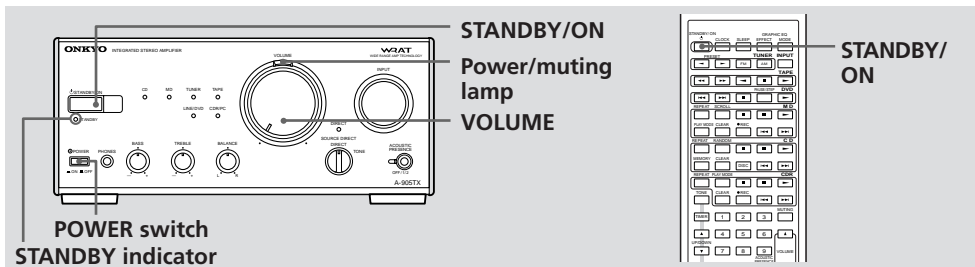

Before turning the unit on

Turn VOLUME control to the leftmost position to avoid damaging the speakers.

1 Connect the AC power cord (mains lead) to the wall outlet (the mains).

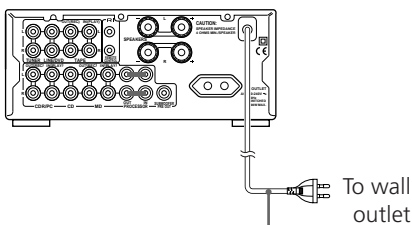

AC power cord (mains lead)

(illustration is 230-240 V models)

2 Press the POWER switch to supply power to the unit.

The STANDBY indicator lights.

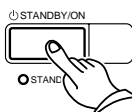

or



Power/muting lamp

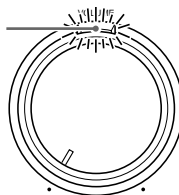

Notes

- The A-905TX is shipped with the main power (POWER) switch in the **ON** position. When the power cord is plugged in for the first time, the A-905TX will automatically enter the standby state and the STANDBY indicator will light (same condition after step 2.)
- If the AC power cord (mains lead) is connected to the AC outlet of another component, that component's AC power cord (mains lead) must be connected to the wall outlet (the mains) to supply power to the unit. If the component has a power switch, it must be set to On.
- Leave POWER switch on. If you set POWER switch to off:
 - the remote controller will not operate, and
 - the timer functions will not operate.
- If you do not use the unit for a long time, set POWER to off by pressing POWER switch again.
- The unit may cause a power surge on your home circuit when you turn it on. If this interferes with any other devices connected to the same circuit, plug this unit into another outlet on a separate circuit.

Choosing the required source

Input source indicators

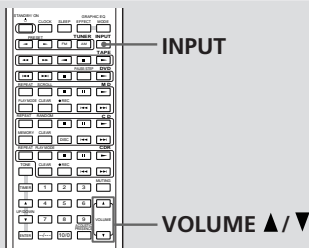
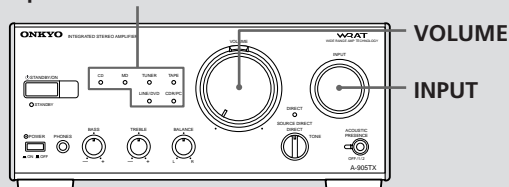

1 Turn **INPUT** selector clockwise or counterclockwise until the input indicator of the source you wish to listen to lights.

Or press **INPUT** button on the remote controller.

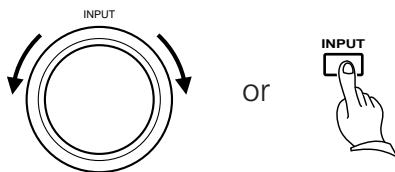

The indicators light in the following order:



When you press the **INPUT** button on the remote controller repeatedly, the indicators light up in clockwise order.

e.g. The CD player is selected.

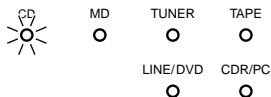

2 Start playing the source you selected in step 1.

3 Set the volume to appropriate level using the **VOLUME** control or **VOLUME ▲ (up) / ▼ (down)** buttons on the remote controller.

Turn **VOLUME** control clockwise to increase the volume or counterclockwise to decrease the volume.

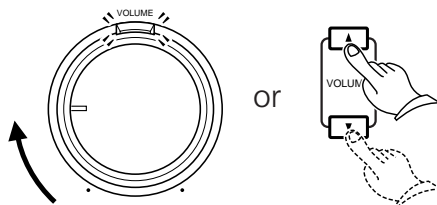

Adjusting the sound

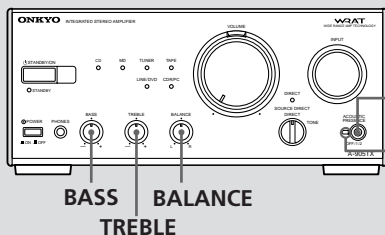

ACOUSTIC PRESENCE Indicator

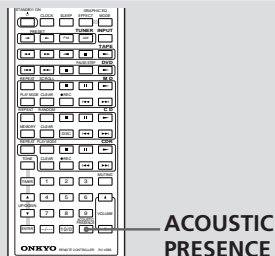

ACOUSTIC PRESENCE

1 Adjust left and right speaker balance.

Turn **BALANCE** control to “L” to lower the volume level of the right speaker, or “R” to lower the volume level of the left speaker.

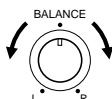

2 Adjust the tone.

The tone can be adjusted from -10 to +10.

Turn **BASS** control to “+” to reinforce the level of the low frequencies, or “-” to attenuate it.

There is no low frequency control at the center position.

Adjust high frequencies.

Turn **TREBLE** control to “+” to reinforce the level of the high frequencies, or “-” to attenuate it.

There is no high frequency control at the center position.

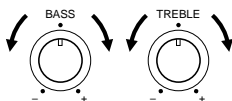

ACOUSTIC PRESENCE

Acoustic Presence adds realism to music through the use of exclusive Onkyo circuitry. Presence settings 1 and 2 are ideally suited for use with compact speakers.

Press **ACOUSTIC PRESENCE** on the unit or remote controller.

The indicator

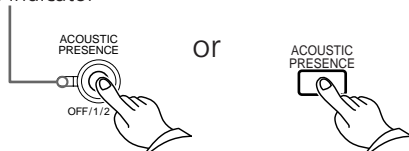

Each press changes the mode as follows:

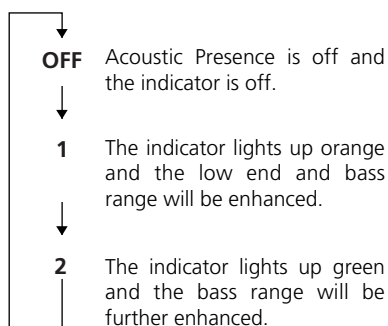

Tip

- Refer to the specifications on page 24 for more information on the boost amount.
- The effect might not be obvious if the source's bass range or low end is weak.

Source Direct function/Muting/Listening with the headphones

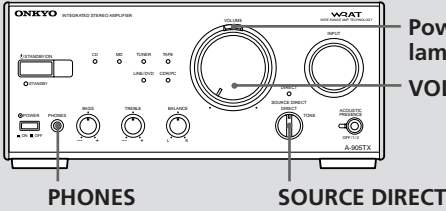

Power/muting lamp

VOLUME

PHONES

SOURCE DIRECT

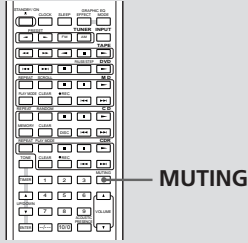

MUTING

SOURCE DIRECT selector

By bypassing the audio circuits of certain controls, the Source Direct function allows you to enjoy a sound closer to the original.

DIRECT: A signal selected via the Input Selector will bypass the BASS and TREBLE controls.

TONE: You can adjust the tonal quality of the signal selected by the Input Selector using the BASS and TREBLE controls.

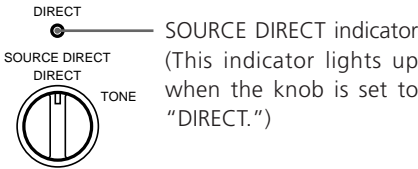

SOURCE DIRECT indicator
(This indicator lights up when the knob is set to "DIRECT.")

Note

If you set the SOURCE DIRECT knob to "DIRECT", you cannot use the tone control function. However, Acoustic Presence mode is enabled. (You can turn it off if you want.)

Muting the sound

Press MUTING button on the remote controller to mute the sound.

The power/muting lamp above the VOLUME control flashes.

To restore the sound, press MUTING button again.

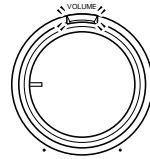
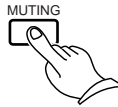

Tip

During muting:

- if you press VOLUME ▲ or ▼ button on the remote controller, the sound will be restored, and
- if you turn off the unit, and turn it on again, the sound will be restored.

Listening with the headphones

Connect the stereo headphones mini plug to the PHONES jack.

The speakers will reproduce no sound while the headphones are connected.

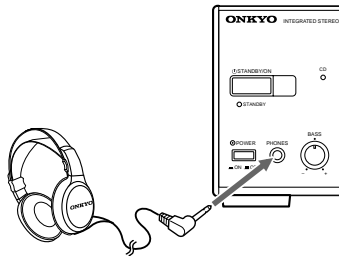

Tip

You can adjust the sound through the headphones as well as through the speakers. See "Adjusting the sound" on the previous page for operations.

Recording

Input source indicators

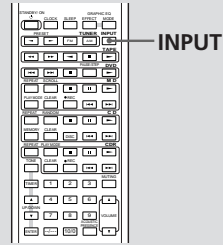
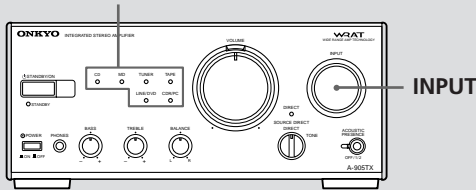

Before recording

Refer to the instruction manuals of the related components for detailed recording operations.

- 1 Turn INPUT selector clockwise or counterclockwise until the input indicator of the source you wish to record from lights. Or press INPUT button on the remote controller.**

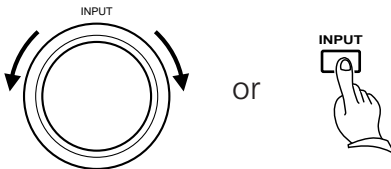

The indicators light in the following order:



When you press the INPUT button on the remote controller repeatedly, the indicators light up in clockwise order.

e.g. The CD player is selected.

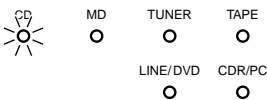

2 Prepare the playing source.

e.g. Insert the CD you want to record from into the CD player.

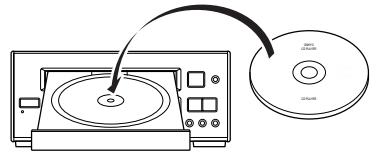

3 Prepare the recording component.

e.g. 1 Insert an MD into the MD recorder.

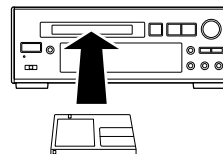

e.g. 2 Insert a cassette into the stereo cassette tape deck.

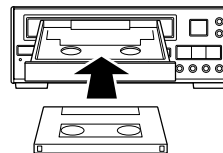

e.g. 3 Insert a blank CD into the CD recorder.

4 Start recording with the component prepared in step 3, then start playing the source prepared in step 2.

Other Information

Troubleshooting

If you have any problems with the unit, please check the troubleshooting table below first. For any problems not covered in the table, please consult your nearest ONKYO authorized service center.

Symptom	Cause	Remedy
The unit doesn't turn on.	The AC power cord is not fully inserted into the wall outlet.	Insert the AC power cord (mains lead) plug into the wall outlet (the mains) securely.
Sound is reproduced from neither left or right speaker.	<ul style="list-style-type: none"> The wire of the speaker cord is touching the other jacks, connectors, or metal parts. The volume level is turned down to the minimum. The sound is muted with the muting function. The headphones are connected to the PHONES jack. Jumper plugs are not connected to the PROCESSOR connectors. 	<ul style="list-style-type: none"> Check the speaker connections (see page 15). Adjust the volume level (see page 19). Press MUTING button on the remote controller to restore the sound (see page 21). Turn down the volume level first, then disconnect the headphones. Then, readjust the volume level. Connect the jumper plugs to PROCESSOR connectors.
Sound is reproduced from only one speaker.	<ul style="list-style-type: none"> The speaker cord is not connected properly or firmly, or is disconnected. The sound is unbalanced between the left and right speakers. Jumper plug is not connected to the PROCESSOR connectors. 	<ul style="list-style-type: none"> Check the speaker connections (see page 15). Adjust the sound balance (see page 20). Connect the jumper plug to PROCESSOR connectors.
No sound is reproduced when the (wake-up) timer operates.	<ul style="list-style-type: none"> The volume level is turned down to the minimum. 	<ul style="list-style-type: none"> Adjust the volume to the proper level when you set the timer (see page 19).
The remote control doesn't operate.	<ul style="list-style-type: none"> The batteries in the remote controller are dead. The remote controller is out of the control range. There is some obstruction between the remote controller and the unit. 	<ul style="list-style-type: none"> Replace the batteries with new ones (see page 17). Operate the remote controller within the control range (see page 17). Try to operate the remote controller from a different angle, or remove the obstruction.

Excessive electrical interference may temporarily render this system's sensitive microcomputer inoperable. If this happens, unplug the system for at least five seconds.

Specifications

Power output

**22 watts per channel, min RMS,
at 4 ohms, both channels driven
1 kHz, with no more than 0.5% THD**

**15 watts per channel, min RMS,
at 8 ohms, both channels driven
1 kHz, with no more than 0.2% THD**

2 × 20 watts at 4 ohms, 1 kHz (DIN)

2 × 14 watts at 8 ohms, 1 kHz (DIN)

2 × 32 watts at 4 ohms, 1 kHz (EIAJ)

Total harmonic distortion

0.2% at rated power

IM distortion

0.2% at rated power

Damping factor

30 at 8 ohms

Frequency and response

15 to 30,000 Hz ± 1 dB

Input sensitivity/impedance

TUNER/LINE/DVD/CD: 200 mV/50 kohms

TAPE PLAY: 200 mV/50 kohms

MD PLAY: 200 mV/50 kohms

CDR/PC PLAY: 200 mV/2.2 kohms

Output sensitivity/impedance

TAPE REC: 200 mV/2.2 kohms

MD REC: 200 mV/2.2 kohms

CDR/PC REC: 200 mV/2.2 kohms

Bass control

± 8 dB at 50 Hz

Treble control

± 8 dB at 10,000 Hz

Acoustic Presence

1: +3 dB at 20.5 Hz, +3 dB at 82 Hz

2: +3 dB at 20.5 Hz, +6 dB at 82 Hz

Signal to noise ratio (IHF-A)

LINE/DVD/CD/MD/CDR/PC: 100 dB

Muting

-50 dB

Power supply

AC 120 V, 60 Hz

AC 230-240 V, 50 Hz

Power consumption

(AC 120 V, 60 Hz) : 63 W

(AC 230-240 V, 50 Hz) : 58 W

Dimensions (W × H × D)

205 × 91 × 302 mm

8-1/16" × 3-9/16" × 11-7/8"

Weight

3.4 kg, 7.5 lbs

Specifications and external appearance are subject to change without notice as a result of product improvement.

Index to parts and controls

For operational instructions, refer to the page indicated in square parentheses.

Front panel

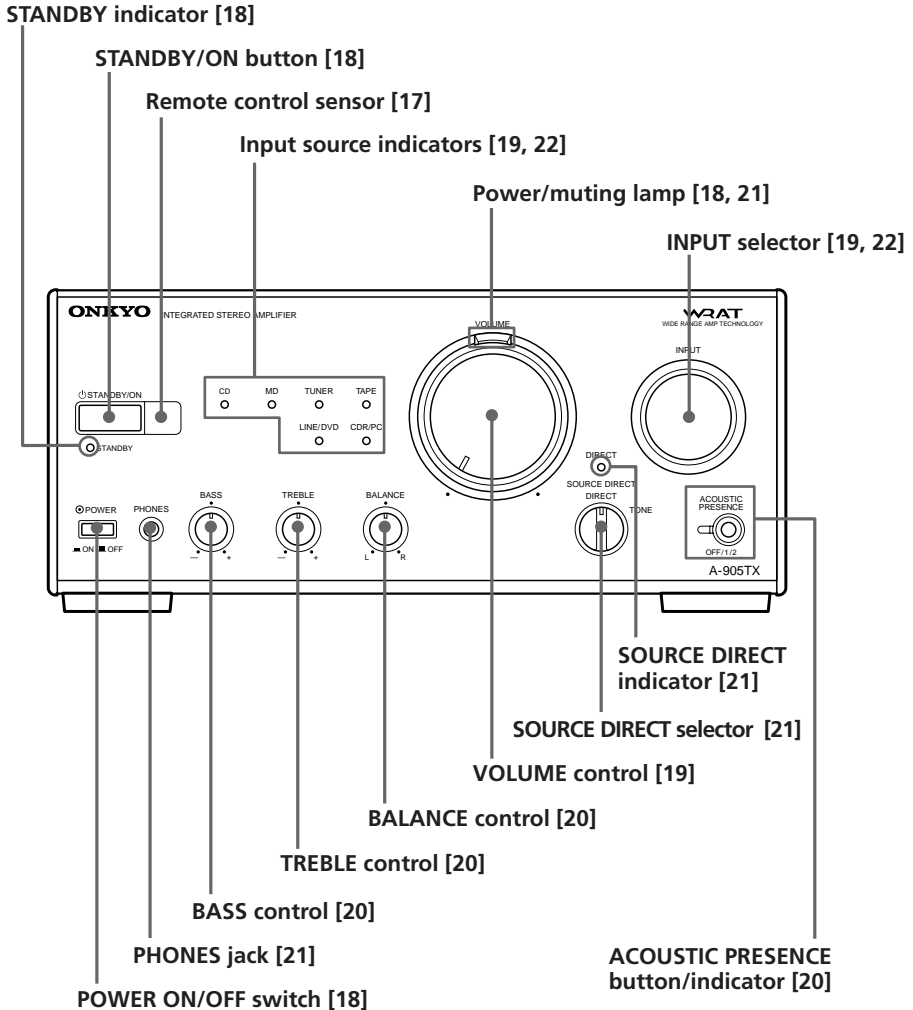

Index to parts and controls

Remote controller

- You can control the other **RI**-connected components with the supplied remote controller.
- The remote controller buttons operate in the same way as the buttons on each component with the same indication.
- For actual operations, please refer to the Instruction Manual for each component.

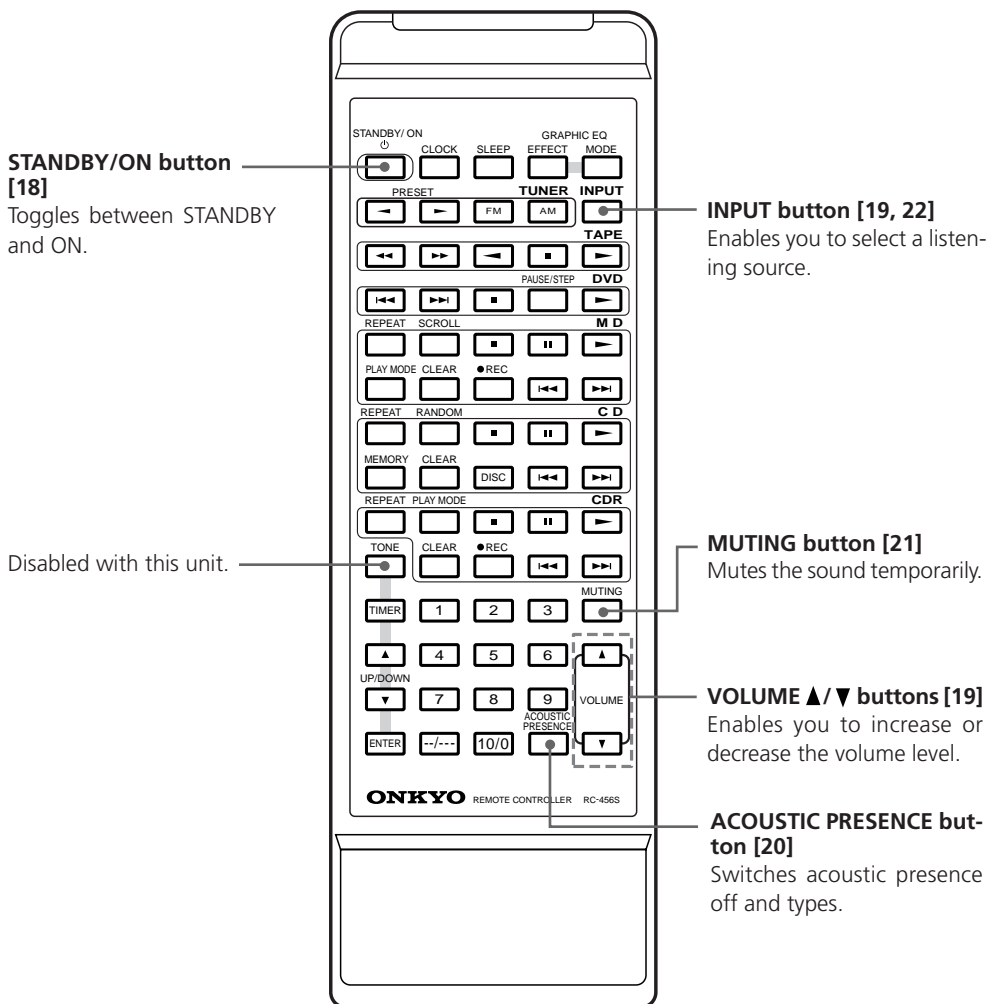

Remote controller

- Use the following buttons to control components that are connected to the **RI**-system.
- Buttons marked with an asterisk (*) cannot be used when the unit is combined with the Separate Collection Series.

Tuner control*

CLOCK : Clock call button
 SLEEP : Sleep timer button
 PRESET ◀ / ▶ : Tuner preset select buttons
 FM: FM band select button
 AM: AM band select button

Stereo cassette tape deck control

▶▶: Fast-forward button
 ◀◀: Rewind button
 ▲: Reverse play button
 ■: Stop button
 ▶: Play button

DVD player control

◀◀: Chapter/track down button
 ▶▶: Chapter/track up button
 ■: Stop button
 PAUSE/STEP : Pause/Step forward button
 ▶: Play button

CD recorder control

REPEAT: Repeat mode button
 PLAY MODE: Play mode selection button
 ■: Stop button
 ||: Pause button
 ▶: Play button
 CLEAR: Clear button
 ● REC: Recording button
 ◀◀: Track down button
 ▶▶: Track up button

Timer setting control (Tuner)*

TIMER: Timer select button
 UP▲ / DOWN▼: Setting select buttons
 ENTER: Enter button

Graphic equalizer control*

EFFECT: Effect select button
 MODE: Mode select button

MD recorder control

REPEAT: Repeat mode button
 SCROLL: Scroll button
 ■: Stop button
 ||: Pause button
 ▶: Play button
 PLAY MODE: Play mode selection button
 CLEAR: Clear button
 ● REC: Recording button
 ◀◀: Track down button
 ▶▶: Track up button

CD player (or changer) control

REPEAT: Repeat mode button
 RANDOM: Random play button
 ■: Stop button
 ||: Pause button
 ▶: Play button
 MEMORY: Memory button
 CLEAR: Clear button
 DISC: Disc button for CD changer
 ◀◀: Track down button
 ▶▶: Track up button

Tuner/CD player (or changer)/MD recorder control

1~9, 10/0: Number buttons
 —/—: Ten's hold button

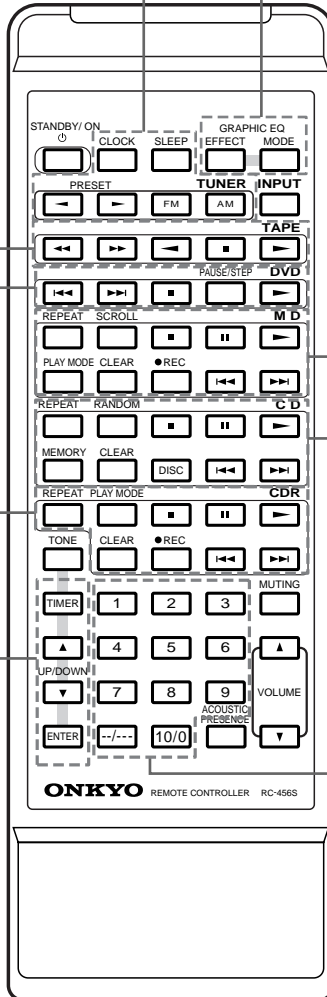

ONKYO CORPORATION

Sales & Product Planning Div. : 2-1, Nisshin-cho, Neyagawa-shi, OSAKA 572-8540, JAPAN
Tel: 072-831-8111 Fax: 072-833-5222 <http://www.onkyo-intl.com>

ONKYO U.S.A. CORPORATION

18 Park Way, Upper Saddle River, N.J. 07458, U.S.A.
Tel: 201-785-2600 Fax: 201-785-2650 <http://www.onkyousa.com>

ONKYO EUROPE ELECTRONICS GmbH

Liegnitzerstrasse 6, 82194 Groebenzell, GERMANY
Tel: +49-8142-4401-0 Fax: +49-8142-4401-555 <http://www.onkyo.net>

ONKYO CHINA LIMITED

Units 2102-2107, Metroplaza Tower I, 223 Hing Fong Road, Kwai Chung,
N.T., HONG KONG Tel: 852-2429-3118 Fax: 852-2428-9039



<http://www.onkyo.co.jp/>

SN 29343066

Printed in Japan
I0103-1

